

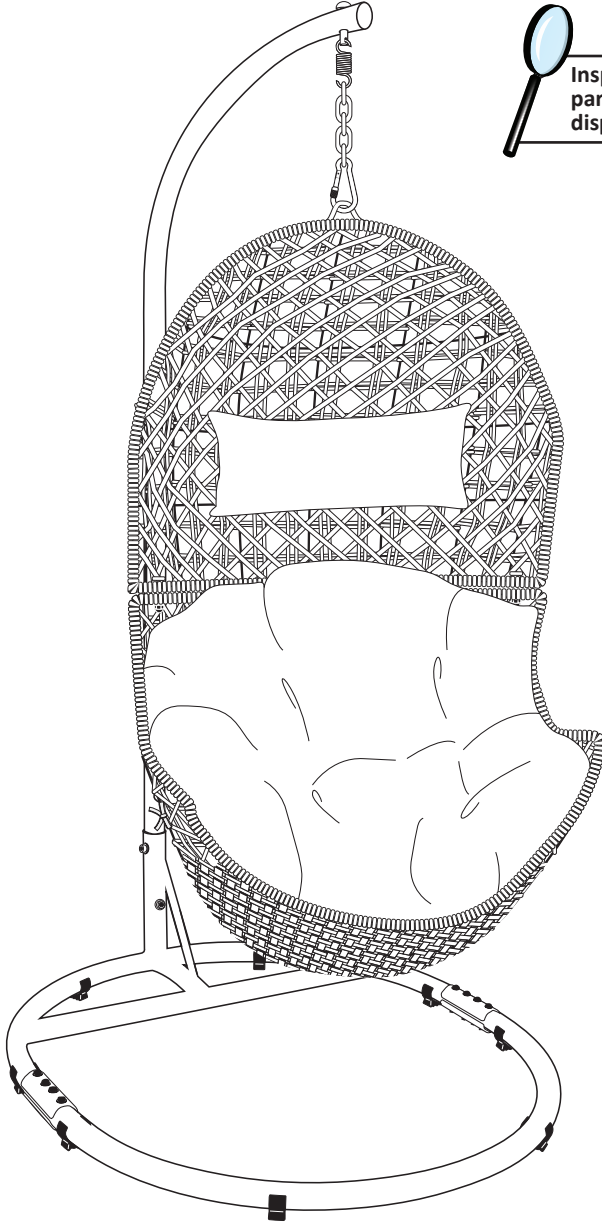









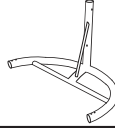





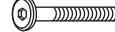





Thank you for choosing Sunnydaze Decor. We stand behind our brand and the quality of the items we sell. Replacement parts or products will be sent at our discretion within the 1-year warranty period. Proof of purchase, with the date of purchase as well as photos of the merchandise defect, must be provided. Photos are used to determine the cause of defects and for future quality control. Register your warranty at <https://tiny.cc/SunnydazeWarranty>. If you have any questions, comments or concerns, feel free to contact us by phone at 833-982-1977, by email: [customerservice@sunnydazedecor.com](mailto:customerservice@sunnydazedecor.com), or via our contact us page at <https://tiny.cc/SunnydazeContact>

# CORDELIA HANGING EGG CHAIR WITH STAND

Read all assembly and care instructions carefully before using this product. Save these instructions for future reference.  
**Assemble components on a soft, clean surface to avoid scratching/damaging the finish.**

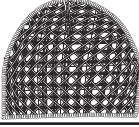

Inspect packaging to ensure all parts are accounted for before disposing of packing materials.

No.	PARTS	QTY.
A	 Base Back	1
B	 Base Front	1
C	 Straight Pole	1
D	 Curved Pole	1
E	 Top Base Connector	2
F	 Bottom Base Connector	2
G1	 M6x45mm Bolt	2
G2	 M6x50mm Bolt	10
H	 M6 Washer	16
I	 Bolt Cap	8
J	 Foot	8
K	 M10x55mm Bolt	2
L	 M10 Washer	8
M	 M10x60mm Bolt	2
N	 M10 Lock Nut	4
O	 Large Hex Nut Cap	4
P	 M6 Lock Nut	4
Q	 Small Nut Cap	4
R	 Pin	1
S	 Extension Spring	1
T	 Safety Strap	1
1	 Chair Top with Carabiner and Chain	1
2	 Chair Bottom	1
3	 Seat Cushion and Pillow	1

## ⚠ CAUTION ⚠

*This egg chair with stand is not to be used as a swing. Bouncing, swinging, or any other significant movements could result in serious injury.*

*This stand must be on a level, stable surface. Ensure the safety strap is attached correctly, and all hardware is securely tightened before every use.*

**Weight Limit: 265 lbs.**

### INCLUDED TOOLS

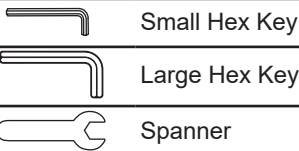

## ⚠ WARNING!

**CHOKING HAZARD** — This item contains small parts that can be swallowed. Keep children and pets away during assembly.

# ASSEMBLY

**TIP:** Ensure all parts align correctly before fully tightening hardware.

## STEP 1

- A: 1
- B: 1
- E: 2
- F: 2
- G2: 8
- H: 8
- I: 8

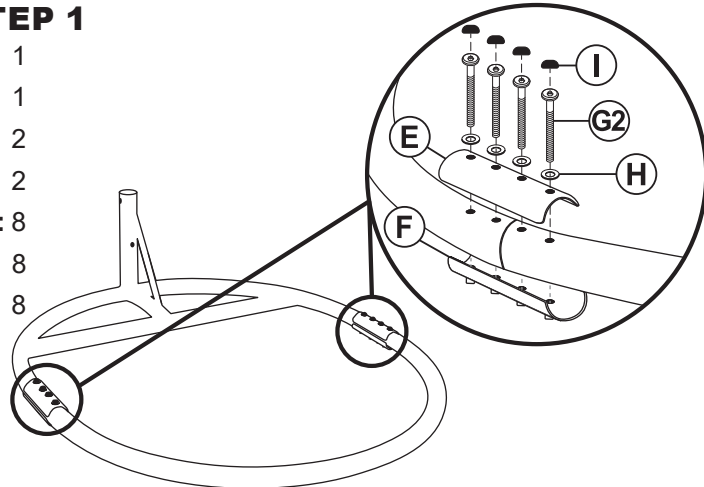

Align Base Back (A), Base Front (B), Top Base Connector (E), and Bottom Base Connector (F) and secure using Washer (H) and M6x50mm Bolts (G2). Place Bolt Caps (I) on the bolt heads.

## STEP 2

- J: 8

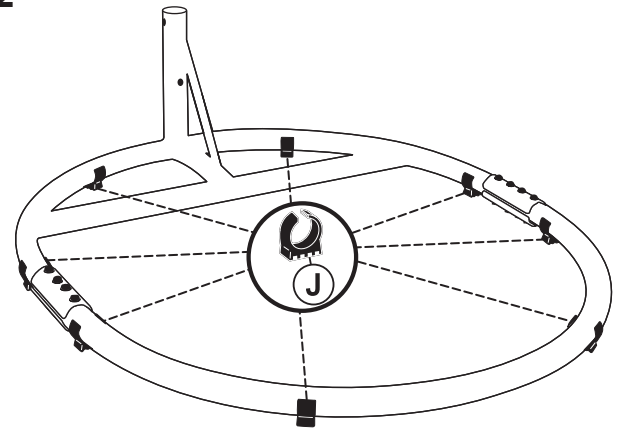

Carefully snap Foot (J) evenly onto the stand base, as shown. **IMPORTANT:** If feet are not evenly distributed the stand could tip over when in use.

## STEP 3

- C: 1
- L: 4
- M: 2
- N: 2
- O: 2

**NOTE:** When installing a lock nut, the metal thread goes on first. Hand-tighten until you feel resistance, which is caused by the nylon insert. A wrench is required to tighten the lock nut fully.

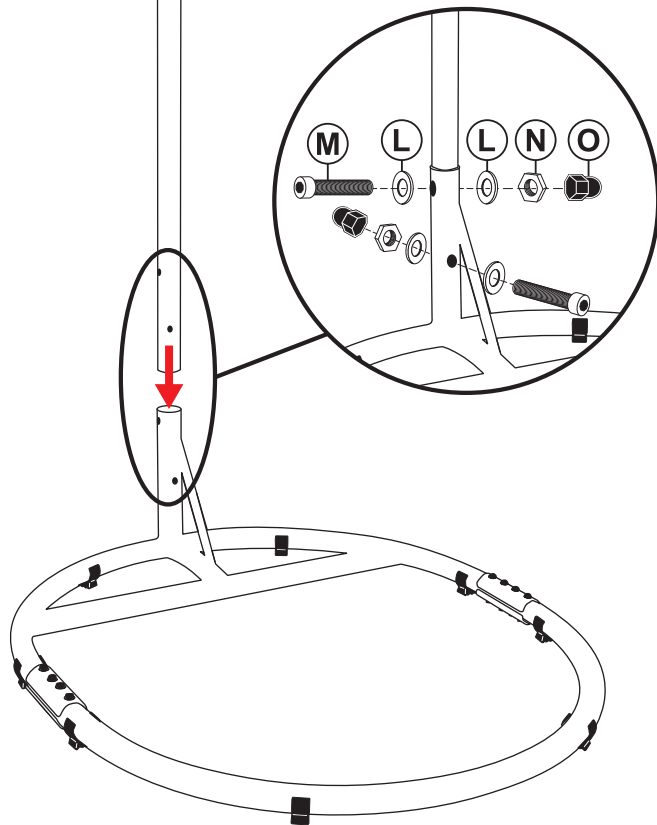

Slide Straight Pole (C) into the back base and align the holes. Secure the pole using M10x60mm Bolts (M), Washers (L), and Lock Nuts (N) as shown. Place Large Hex Nut Caps (O) over the lock nuts.

## STEP 4

- D: 1
- K: 2
- L: 4
- N: 2
- O: 2

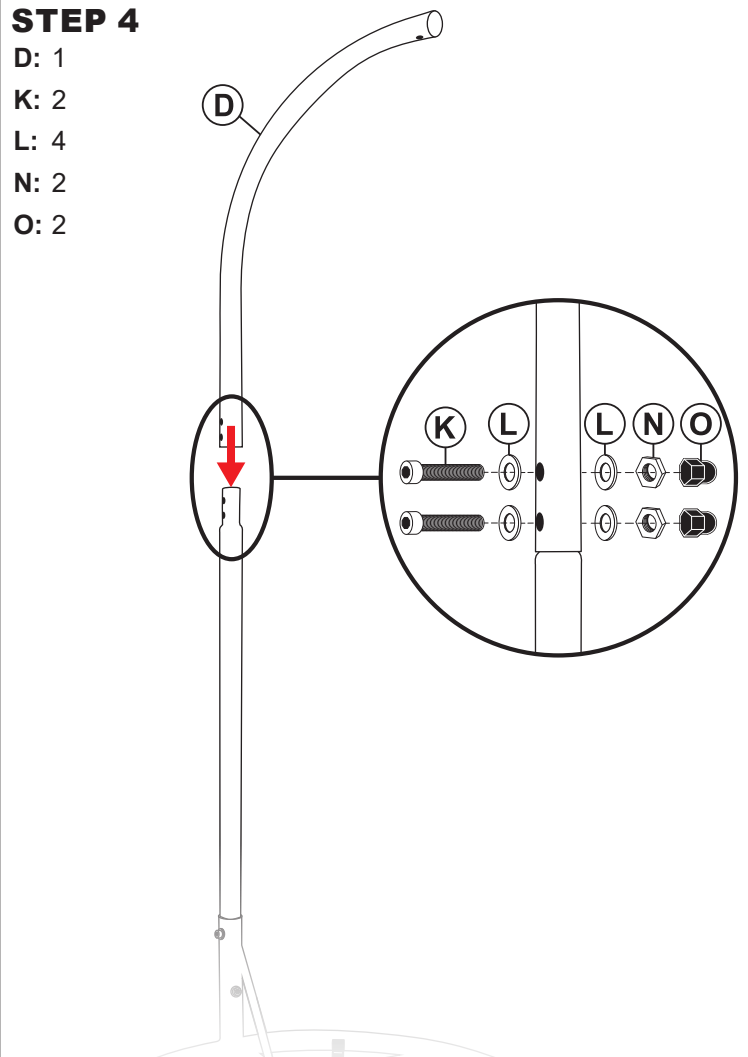

Slide Curved Pole (D) onto Straight Pole (C) and align the holes. Secure the poles using M10x50mm Bolts (K), Washer (L), and Lock Nuts (N) as shown. Place Large Hex Nut Caps (O) over the lock nuts.

### STEP 5

- 1: 1      H: 8
- 2: 1      P: 4
- G1: 2    Q: 4
- G2: 2

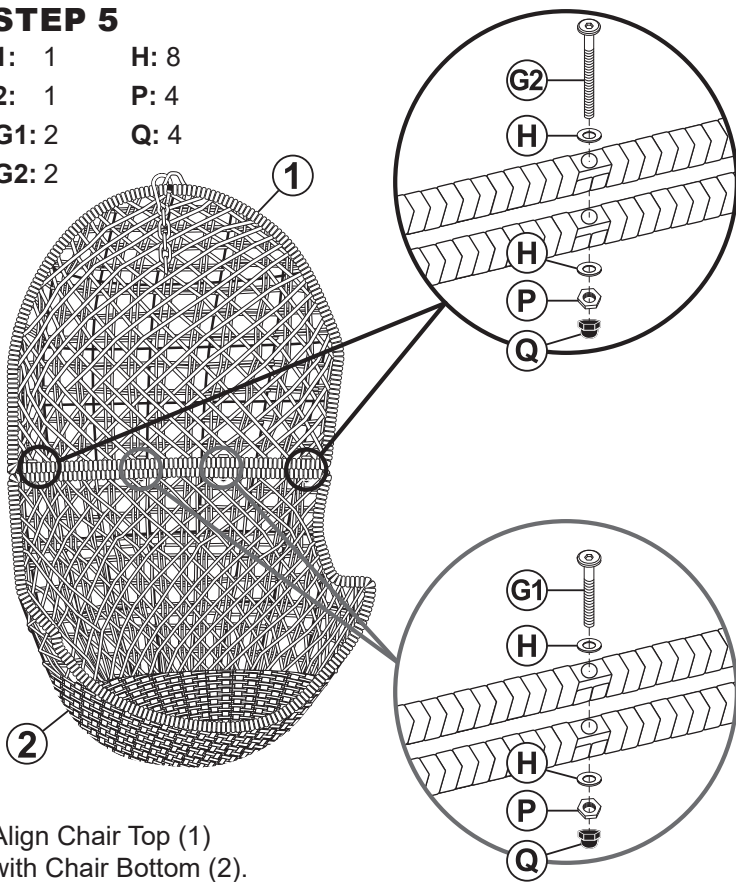

Align Chair Top (1) with Chair Bottom (2).

As shown, hand-tighten M6x50mm Bolts (G2), Washers (H) and Lock Nuts (P) to the outside mounting holes. Then, hand-tighten M6x45mm Bolts (G1), Washers (H) and Lock Nuts (P) into the center mounting holes.

Fully tighten hardware and place Nut Caps (Q) over the nuts.

### STEP 6

- R: 1
- S: 1

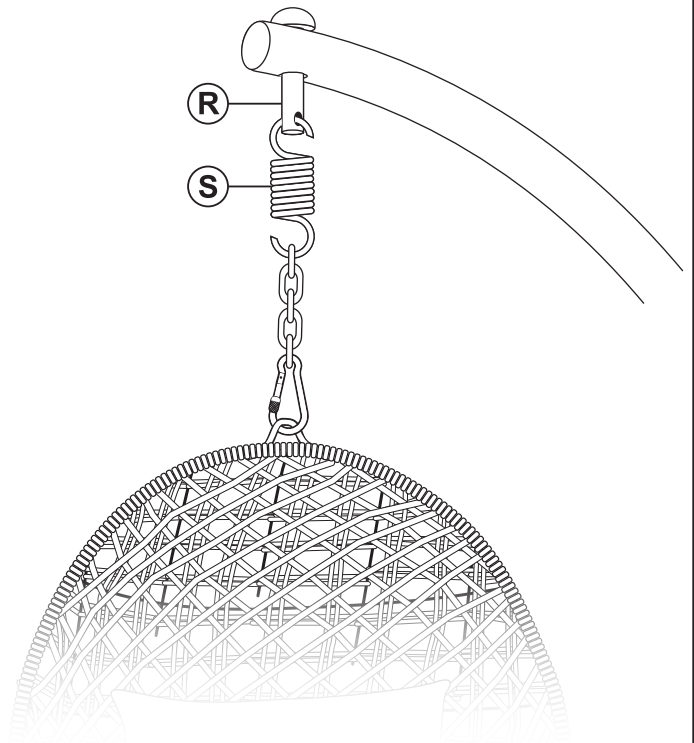

Place Pin (R) into the top of the curved pole. Insert Extension Spring (S) through the bottom of Pin (R).

Hang the egg chair on Extension Spring (S).

### STEP 7

- T: 1

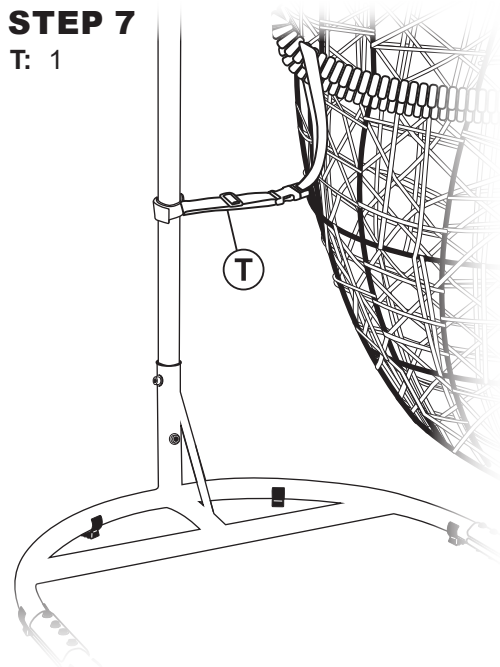

#### IMPORTANT:

Do not tie the pillow or seat cushion to the rattan material, as doing so may cause the rattan to break and unravel.

Wrap the hook and loop fastener that is sewn onto Strap (T) around Pole (C). Loop the strap through the back of the egg chair and connect the buckles, tighten strap as needed.

### STEP 8

- 3: 1

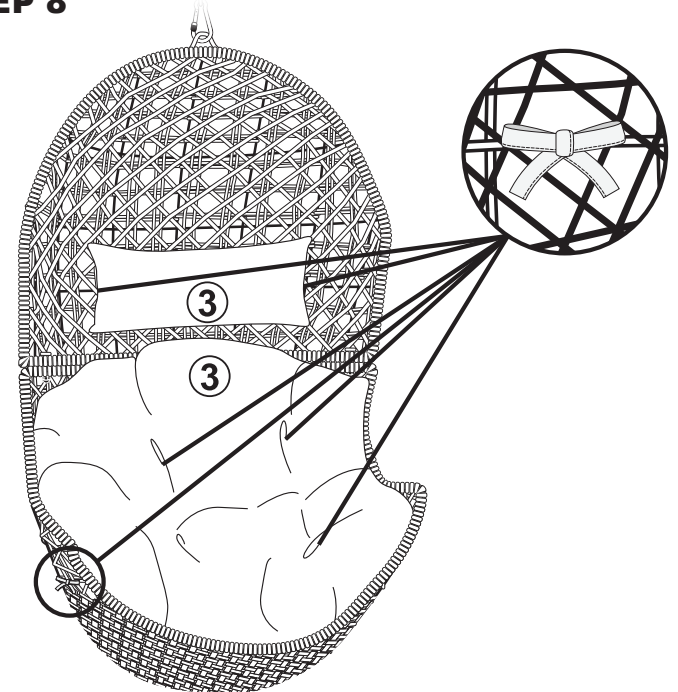

Tie Seat Cushion and Pillow (3) onto the frame of the egg chair.

**NOTE:** Do not tie cushions to the rattan material.

# Care & Maintenance

With proper care and under normal use, Sunnydaze Egg Chairs and Chair Stands will last for years.

It is important to follow basic use & care tips to prolong the life of your egg chair and stand.

- **SAFE USE:** Do not use this chair for swinging, bouncing, jumping, twisting, or other excessive movements; doing so may cause serious injury, including, but not limited to, the stand tipping over. Do not use the stand without the safety strap; this strap helps keep the chair safely in place while getting in and out of the chair.
- **CHILDREN:** Supervise children at all times. Do not allow children to play on or sleep in hanging chairs.
- **INSPECTION:** Ensure the stand is assembled correctly, the hardware is securely tightened, and the safety strap is buckled before each use.
- **CLEANING:** Use a soft cloth, warm water, and mild detergent to wipe down the stand. Dry the stand after cleaning to prevent rust. Spot-clean the cushions with a damp cloth. For tougher stains, use mild detergent and a soft cloth to scrub gently. Rinse thoroughly and air-dry cushions to prevent mold and mildew growth.
- **SCRATCHES:** The powder coating on the stand is tough and durable but, even under normal use, some scratching is inevitable. To avoid excessive rust, wipe these areas as needed to remove moisture.
- **WINTER CARE & STORAGE:** Store the chair and stand indoors during winter and inclement weather. Cool, dry locations are best to help prevent damage. Exposure to moisture may cause the stand to rust and could cause mold and mildew growth on the cushions and chair. Prolonged exposure to sunlight will cause the cushions, chair, and stand to fade.

## Troubleshooting

- If the stand feels unstable, make sure it is on a level surface, and the feet are correctly and evenly distributed.
- If the stand is making noise when in use, check to ensure all hardware is tightened. Some noise created by the hanging hardware is normal.

*If you experience issues with assembly or the product was damaged during shipping, please contact our customer service team through one of the methods mentioned at the top of page 1.*

*Please have the item number and order information ready to expedite response time.*

## ! SAFETY STATEMENTS & WARNINGS !

- Weight limit: 265 pounds
- For residential use only. This product is intended to be used by one person at a time. Do not allow children to use this product without adult supervision.
- Sunnydaze Egg Chair is not a swing. Therefore, do not swing, bounce, jump, twist, or spin in the chair.
- Use care when getting in and out of the chair. When in use, the chair should remain inside the base area at all times. A diagram of the base area is shown on the right.
- The chair must be used with the provided safety strap attached to the chair and stand, as shown in Step 7.
- This item must be used with all provided parts. Install all parts in accordance with the assembly instructions and inspect the stand before use.
- When securing the chair to the stand, only loop the safety strap around the frame of the chair. Never loop the safety strap around the rattan material of the chair, as it will break the rattan material, which may cause it to unravel.
- Always inspect the stand and hardware for damage before each use. Ensure all hardware is securely installed and tightened before every use.

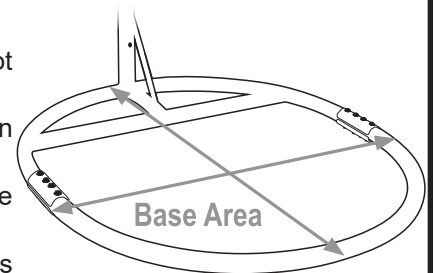

**Any modification to the product or failure to follow recommended care will void the product warranty.**

## ! WARNING:

**Manufacturer and seller expressly disclaim any and all liability from personal injury, property damage or loss, whether direct or indirect, or incidental, resulting from the incorrect attachment, improper use, inadequate maintenance, or neglect of this product.**