

Thank you for choosing Sunnydaze Decor. We stand behind our brand and the quality of the items we sell. Replacement parts or products will be sent at our discretion within the 1-year warranty period. Proof of purchase, with the date of purchase as well as photos of the merchandise defect, must be provided. Photos are used to determine the cause of defects and for future quality control. Register your warranty at <https://tiny.cc/SunnydazeWarranty>. If you have any questions, comments or concerns, feel free to contact us by phone at 833-982-1977, by email: customerservice@sunnydazedecor.com, or via our contact us page at <https://tiny.cc/SunnydazeContact>

STAINLESS STEEL DUAL ZONE BEVERAGE REFRIGERATOR

ATN-385

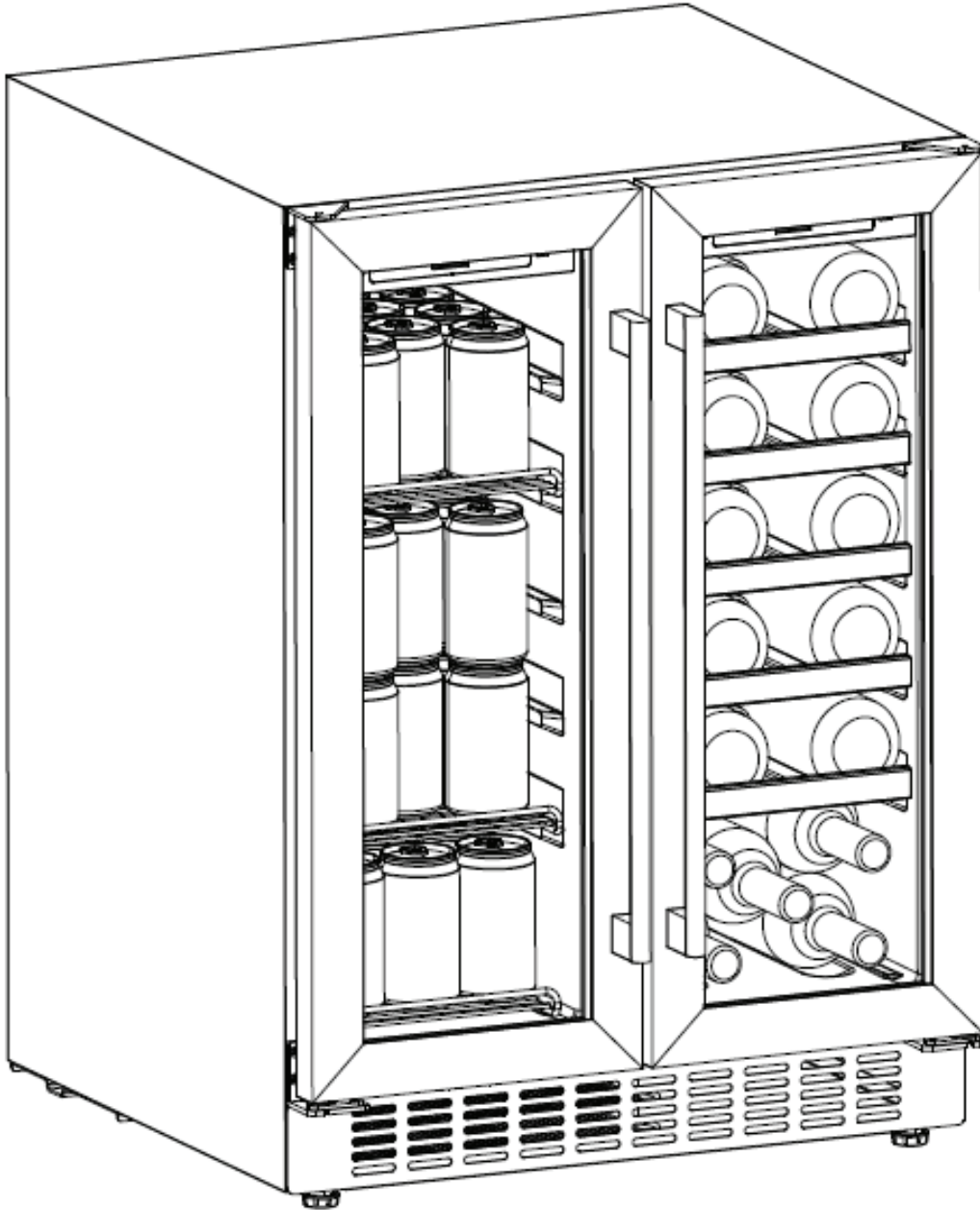

Inspect packaging to ensure all parts are accounted for before disposing of packing materials.

PARTS	QTY.
Main Cabinet	1
Door Handle	2
M4 x 40mm Bolt	4
Small Chrome Wire Shelf	1
Large Chrome Wire Shelf	2
Wooden Shelf	5

TOOLS REQUIRED (not included)

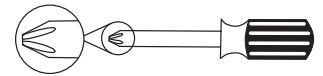

Phillips Screwdriver

NOTE: Shelves, door frame, handle and other accessories styles may vary by model and configuration. All drawings in this manual are for reference.

Table of Contents

Safety Instructions	3
Electrical Connection	4
Technical Data	4
Appliance Features	5
Handle Installation	5
Installation Requirements.....	6
Operation	7-8
Maintenance & Cleaning.....	9
Troubleshooting	10



General Operating Instructions

Remove all packaging and labels from your beverage cooler. Be sure that all parts have been included before discarding any packaging materials. You may want to keep the box and packing materials for use at a later date.

Please read and follow all safety instructions and operating instructions before using.

— SAVE THESE INSTRUCTIONS —

To register your product, visit:
<https://tiny.cc/SunnydazeWarranty>

Please retain your proof of purchase for warranty services.

Any modification to the product or failure to follow recommended care will void the product warranty.



Important Safety Instructions



To reduce the risk of fire, electrical shock or injury when using your appliance, follow these basic precautions:

- Do not operate this or any other appliance with a damaged cord.
- Do not operate if housing is removed or damaged.
- Exercise caution and use reasonable supervision when appliance is used near children. Never allow children to operate, play with or crawl inside the appliance. Keep packing materials away from children.
- Do not use this appliance for anything other than its intended purpose. For freestanding, indoor, household use only. Any other use will void the warranty.
- Before performing any maintenance or cleaning, ensure that the unit is unplugged.
- Never unplug the appliance by pulling on the power cord. Always grasp the plug firmly and pull straight out from the outlet.
- Do not clean appliance with flammable fluids. Do not store or use gasoline or other flammable vapors and liquids in the vicinity of this or any other appliance. The fumes can create a fire hazard or explosion.
- To ensure proper ventilation for your appliance, the front of the unit must be completely unobstructed. Choose a well-ventilated area with temperatures above 60°F and below 90°F.
- Locate the unit away from direct sunlight and heat sources (stove, heater, radiator, etc). This unit is intended for indoor use only and must be installed in an area protected from the elements.
- Place the appliance on a solid, level surface.
- Do not place any other objects on top of the wine cooler.
- Do not attempt to repair or replace any part of your appliance unless it is specifically recommended in this manual. All other servicing should be referred to a qualified technician.
- Connect to properly polarized outlets only. It is recommended that a separate circuit serving only your appliance be used. Use receptacles that cannot be turned off by a switch or pull chain.
- Be sure that the plug is fully inserted into the receptacle.
- Use of an extension cord for the wine cooler is not recommended. Directly connect the wine cooler to an electrical outlet.
- To protect against electric shock, do not immerse appliance, plug or cord in water or other liquids.
- Avoid installing the unit in high-moisture areas.
- This appliance is designed to be freestanding only.
- Do not operate the unit with wet hands, while standing on a wet surface, or while standing in water.
- Do not use solvent-based cleaning agents or abrasives on the interior of the cooler. These cleaners may damage or discolor the interior.
- Keep fingers out of pinch point areas and be careful when closing doors.
- This appliance is designed for storing and cooling wines. Do not store perishable food or medical products within the unit.
- To ensure proper internal air circulation, do not overfill the wine cooler.
- When disposing of refrigeration appliances, special handling is often required. It is the consumer's responsibility to comply with federal and local regulations when disposing of this product.
- **WARNING:** Risk of child entrapment and suffocation. Before you throw away this or an old unit, remove the door. Leave the shelves in place so that children may not easily climb inside.

Electrical Connection



Improper use of the grounded plug can result in the risk of electrical shock. If the power cord is damaged, frayed or shows cracks or abrasions across its length, have it replaced at an authorized service center.

For your protection, this unit is equipped with a 3-conductor cord set that has a molded 3-prong grounding-type plug, and should be used in combination with a properly connected grounding-type outlet. A ground fault circuit interrupter (GFCI) type is not recommended because it may cause interruption of operation.

- Do not under any circumstances cut or remove the third ground prong from the power cord supplied. For personal safety, this appliance must be properly grounded.
- The cord should be secured behind the unit and not left exposed or dangling to prevent accidental injury.
- A standard electrical supply (110V AC only, 60Hz), properly grounded in accordance with the National Electrical Code and local codes and ordinances, is required.
- Do not connect to a circuit that is turned on and off by a switch.
- Never unplug the unit by pulling the power cord. To disconnect the appliance, always grip the plug firmly and pull straight out from the wall outlet. When moving the unit, be careful not to damage the power cord.
- The unit should always be plugged into its own individual electrical outlet with a voltage rating that matches the rating label on the unit.

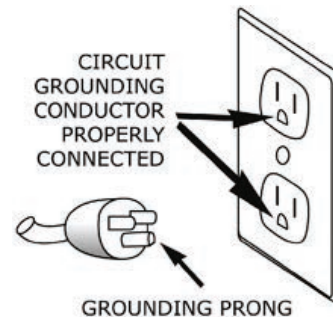

! CAUTION: Do not use an adapter or an extension cord with this unit.

Technical Data

Product Model	JCF-116S
Capacity	63 cans/12 oz and 20 bottles/750 ml
Voltage/Frequency	115V~
Frequency	60Hz
Power Consumption (kWh/24h)	1.150 (32.2°C ambient temp and 12.8°C inner temp)
Refrigerant/Weight	R600a/0.64oz
Total Volume	3.96 cu.ft
Approx. Net Weight	94.4 lbs (42.8 kg)
Unit Dimensions (WxDxH)	23.43" x 22.4" x 32.48-34.25" 595 x 570 x 825-870 mm

PLEASE NOTE:

1. The Approx. Net Weight includes shelves, and the Unit Dimension is without handle on the door.
2. Loading capacity will vary in terms of beverage arrangement as well as can and bottle sizes.
3. The product height could be adjusted from 870 to 890 mm by 4 plastic feet.
4. Power consumption is calculated when the ambient temperature is 32.2°C and the inner temperature is set to 12.8°C.

Technical data and performance information is for reference only. Specifications are subject to change. Check the rating label on the appliance for the most accurate information.

Appliance Features

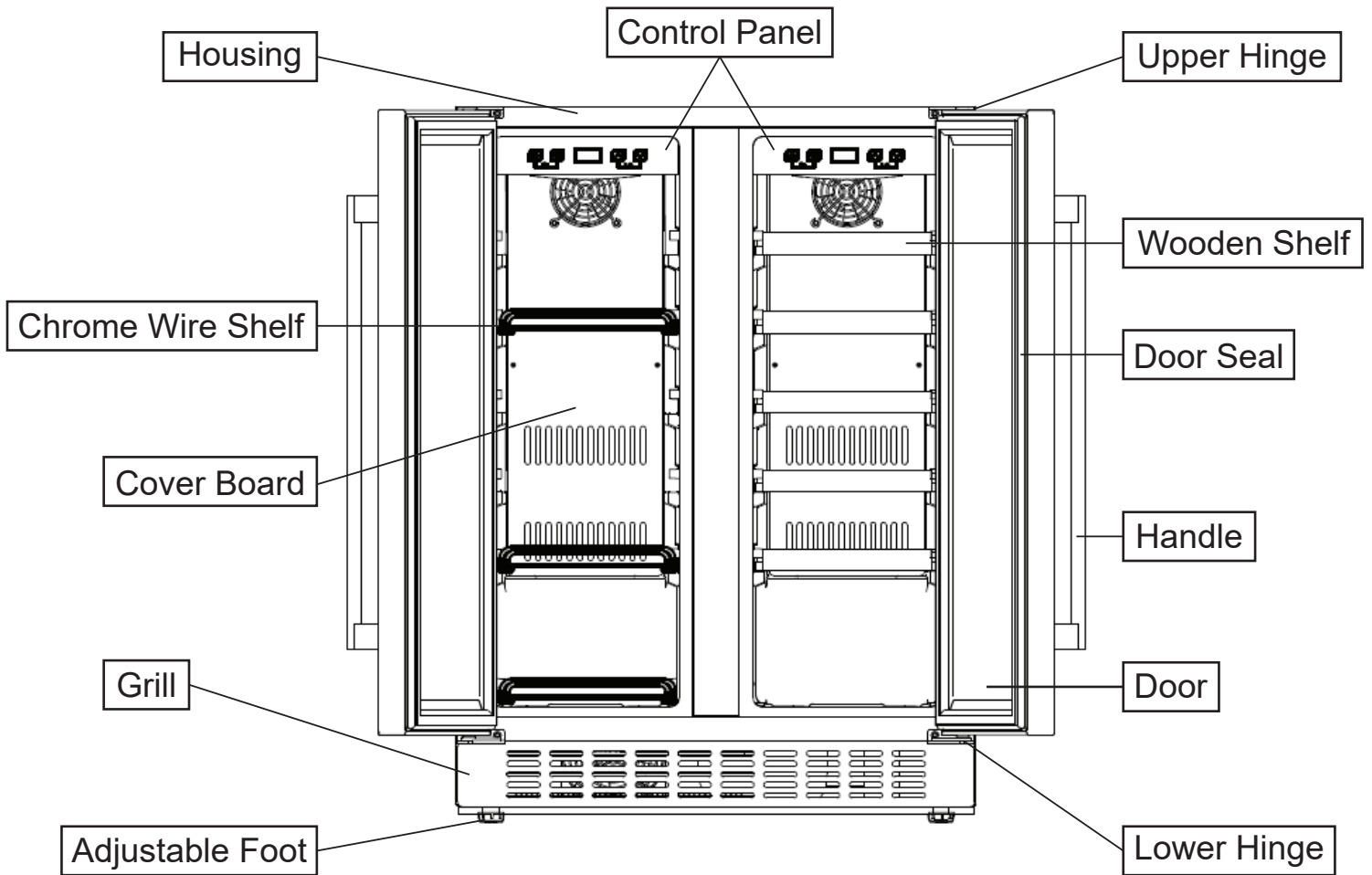

NOTE: Shelves, door frame, handle and other accessories styles may vary by model and configuration. All drawings in this manual are for reference.

Handle Installation

①	Door
②	Handle
③	Door Seal
④	Bolts



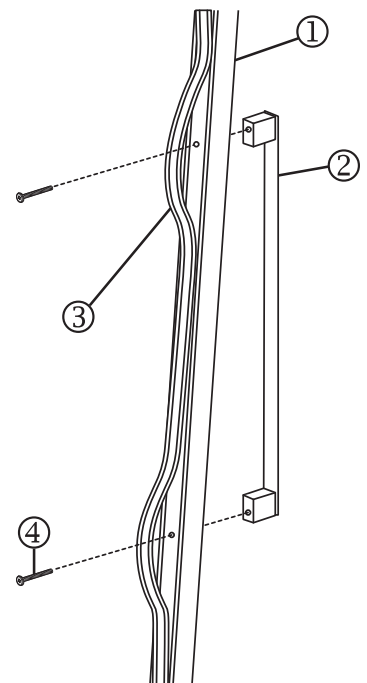



1. On the door interior, gently and carefully pull the door seal out to expose the two small holes where the handle will be mounted.
2. Align the handle with the holes on the outside of the door.
3. Insert the included bolts into the small holes on the inside of the door, use a screwdriver (not included) to tightly fasten the handle.
4. Press the door seal back into place to cover the bolts, ensuring that the seal is in full contact with the door.



Installation Requirements

The appliance is designed to for freestanding installation only.

Clean the interior surface with lukewarm water and a soft cloth before the first use.

-  Before connecting the appliance to the power source, let it stand upright for approximately 24 hours. This will reduce the possibility of a malfunction in the cooling system from handling during transportation.
-  Do not tilt the appliance more than 45° when moving it into position.
-  The appliance must be on a dry, firm, and level surface that is able to support the entire weight of a fully-loaded unit. It is important for the appliance to be level in order to work properly. If needed, adjust the height by rotating the adjustable feet.
-  Do not use the appliance in locations that are wet or are exposed to extreme heat or cold.
-  For indoor, residential use only. Do not install outside or in any location that is not climate controlled. Dry and/or air-conditioned areas are recommended to avoid condensation on the door.
-  Keep the appliance away from direct sunlight or other heat sources.

Under-Counter Installation

Select a location where the unit can be plugged directly into a grounding-type outlet. See Electrical Connection (page 4) for guidelines.

Place the unit on a non-combustible pad such as a carpet remnant to help protect the floor surface when sliding the unit into position.

To ensure proper service access, ventilation, and optimal performance, allow at least 2-3 inches of clearance around the back, sides, and top of the unit. This unit can NOT be installed behind closed doors; the front frill MUST remain unobstructed.

When installing against a cabinet or wall that extends beyond the front edge of the unit, allow at least 90° door swing clearance to provide the shelves necessary space to slide out.

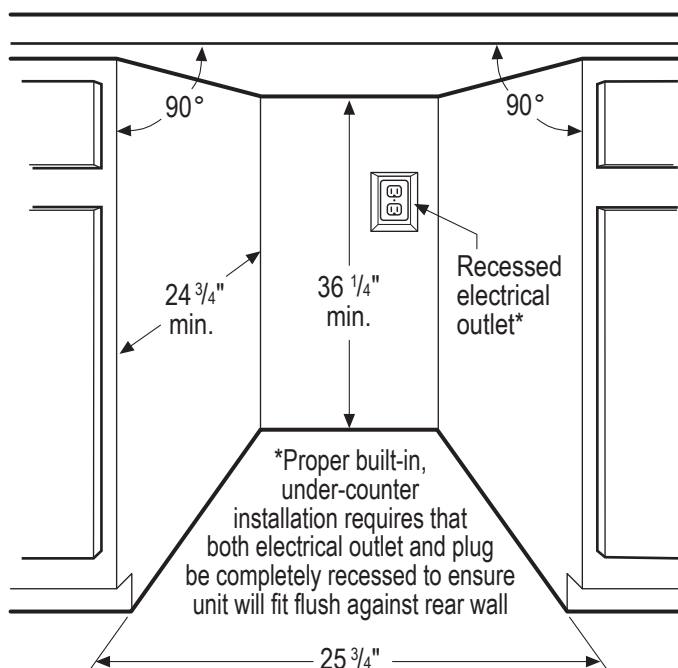

Operation

Before Operation Checklist

Before power is turned on, make sure the following steps have been taken:

- PACKING MATERIAL:** All packing material and tape have been removed from the interior and exterior of the unit.
- CLEANING:** Clean the appliance and check the drainage pipe to ensure a good connection.
- STILL AND LEVEL:** Ensure the appliance is level on the firm and dry floor and has remained upright and still for 24 hours.
- CLEARANCE:** The appliance has clearance of 2-3 inches around the back, sides and top of the unit to ensure proper ventilation.
- POWER ON:** Allow the interior to cool to the desired temperature before storing beverages.

Control Panel



--- Buttons do not function while in Lock Mode. Unlock the control panel to begin. ---

ON/OFF

Turns the unit on and off. Press and hold the button for approximately 3 seconds.

LIGHT

Press the button to turn the inner LED light on or off. The button does not function in stand-by mode.

Lock (multi-button functionality)

To lock or unlock the control panel, the ON/OFF and LIGHT button must be pressed at the same time. Press and hold both buttons for approximately 3 seconds. The unit will beep when the control panel (un)locks.

UP

Press the button once, the LED display will flash and show the current set temperature. Each press of the UP button will increase the set temperature by 1°F. Flashing will stop after 5 seconds and the temperature setting will save. The LED display will return to showing the actual temperature inside the unit.

Down

Press the button once, the LED display will flash and show the current set temperature. Each press of the DOWN button will decrease the set temperature by 1°F. Flashing will stop after 5 seconds and the temperature setting will save. The LED display will return to showing the actual temperature inside the unit.

Fahrenheit/Celsius Display Interchange (multi-button functionality)

Switch between Fahrenheit and Celsius by pressing the UP and DOWN button at the same time.

Attention

1. Cooling temperature: The left and right zone have separate control panels to set cooling temperatures.

Left Zone: 32°F - 50°F

Right Zone: 41°F - 68°F

2. Alarm sound: when a system malfunction occurs and the alarm sounds, press any key on the control panel to cancel the alarm sound.

3. Error code: an alarm will be set off when an error occurs. Press any button to turn the alarm off.

Left Zone

E1	Temperature Sensor - Open circuit
E2	Temperature Sensor - Short Circuit
E3	Defrost Sensor - Open Circuit
E4	Defrost Sensor - Short Circuit

Right Zone

E5	Temperature Sensor - Open circuit
E6	Temperature Sensor - Short Circuit
E7	Defrost Sensor - Open Circuit
E8	Defrost Sensor - Short Circuit

Wine Storage

• Full appliance loading capacity:

Left Zone: 63 cans (standard soda 12 oz)

Right Zone: 20 bottles (standard Bordeaux with 750ml)

• Loading capacity will vary in terms of beverage arrangement as well as can and bottle sizes.

• Each zone shelf is designed to hold 1 or 2 layers of beverages. Do not exceed 2 layers of wine bottles per shelf in the right zone.

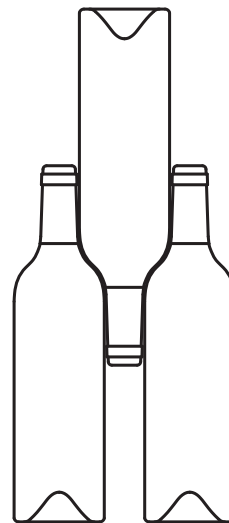
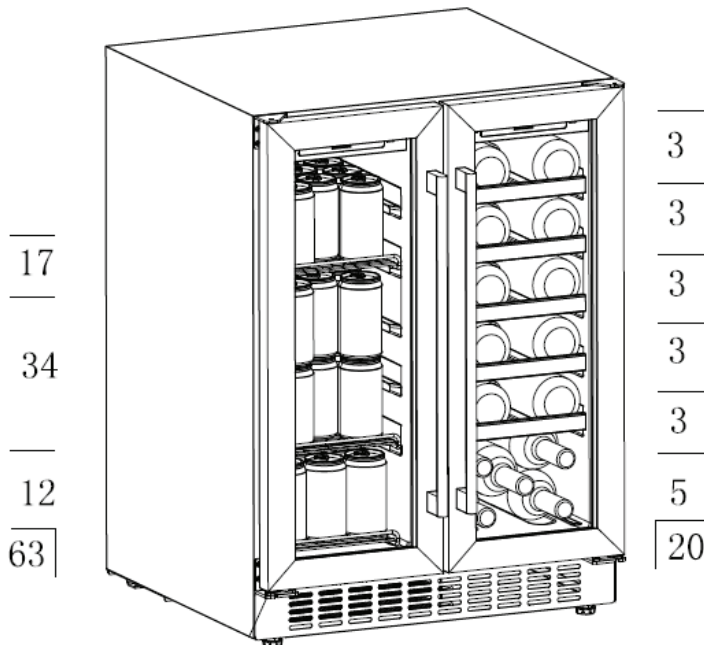

- Open the door far enough to pull the shelves straight out.
- Each shelf pulls out partly to store wine bottles easily.
- If the wine cooler will not be used for an extended period of time, it is recommended to power it off, clean it carefully, and open the door for ventilation.
- Although optimal storage temperature is generally regarded to be 53-57°F, different varieties of wine require different service temperature settings. The recommended temperature ranges for serving different varieties of wine are listed below.

HELPFUL HINTS

Allow the wine cooler to reach the desired temperature before adding wine bottles.

If the unit has been powered off, wait at least 5 minutes before powering it back on.

Red Wine	59-65°F
White Wine	48-57°F
Rose Wine	50-52°F
Champagne & Sparkling Wine	41-47°F

Maintenance and Cleaning

Moving the Appliance

- Unplug the power supply from the electrical outlet.
- Remove all contents from the appliance.
- Defrost and clean the unit before moving.
- Tape the door shut to prevent it from opening.
- Transport the appliance in an upright position.
- When moving the appliance, do not tip the appliance more than 45°.



Power Cut/Power Outage

Avoid opening the door as much as possible. During extended power cuts/outages, take the necessary measures to protect your wine from becoming too warm or hot.

 Wait at least 5 minutes after power is disconnected or a power outage to restart the appliance.

Out of Service for a Long Time

Remove all bottles and shelves from the appliance, turn the power off, defrost, clean, and dry all surfaces. Place the shelves back inside the unit and leave the door open to prevent mold.

Cleaning

- Unplug the appliance and remove all bottles and shelves before cleaning.
- Clean the appliance with warm water and a soft cloth or sponge.
- Do not use organic solvents, alkaline detergent, boiling water, washing powder or acid liquid etc.
- Do not flush the compartment of the appliance.
- Regularly clean surfaces that can come in contact with accessible drainage systems.
- **DO NOT** use alkaline detergents, solvents, brushes, or boiling water to clean the unit.



Risk of electric shock!

ALWAYS turn the beverage cooler **OFF** and unplug the power cord from the outlet before cleaning, performing maintenance, or moving the unit. Failure to do so could result in electric shock, fire, or personal injury.

Troubleshooting

PROBLEM	POSSIBLE CAUSE/SOLUTION
The appliance is making noise?	The appliance may not be level. Adjust the feet until the unit is level.
	The appliance may have inadequate ventilation. Ensure the unit is far enough away from walls and the ambient temperature is not too high.
Flowing liquid sound in cabinet?	This is a normal sound from the refrigerant working inside the cabinet.
The appliance does not start?	Make sure the appliance is connected to the power properly.
	Make sure switch on the power.
	The compressor requires 5 minutes to restart after a power cut/outage.
Compressor runs continuously?	Make sure the ambient temperature is not too high.
Door does not seal tightly?	Over time, the door seal might get stiff and distorted partially. Carefully heat the door seal with a blow dryer or hot towel to soften the seal and close the door. If the door will not seal, contact us for a replacement door seal via one of the methods at the top of page 1.
The appliance does not cool sufficiently?	Adjust the temperature setting on the control panel.
	Allow the unit to cool to the desired temperature before loading bottles.
	If the door is fully closed or the door frequently opened, the unit will not cool sufficiently. Keep the door closed as much as possible.
	Keep the appliance away from sunlight or heat.
Unpleasant smell inside cabinet?	A slight odor is normal when the unit is first used and should go away after a short time.
	Clean the compartment and ventilate it for a few hours.
Condensation on the glass door?	High ambient temperature and humidity can cause condensation. Avoid using the appliance in these conditions. Also, avoid setting the inside temperature too low.
	Condensation can be caused by opening the door often. Avoid frequently opening and closing the door.
The light isn't working?	Make sure the appliance is plugged in and the power supply is working.
	The light may need to be replaced.

⚠ CAUTION: Use only original replacement parts. This appliance must use design-specific parts. Do not substitute or use generic parts. Improper replacement parts could cause serious or fatal injuries. This will also protect your warranty coverage for parts replaced under warranty. Some parts may not be serviceable or replacement.

Any modification to the product or failure to follow recommended care will void the product warranty.

⚠ WARNING!

Manufacturer and seller expressly disclaim any and all liability from personal injury, property damage or loss, whether direct or indirect, or incidental, resulting from the incorrect attachment, improper use, inadequate maintenance, or neglect of this product.